

# Two-Handle 4.0" (102 mm) Deck-Mount Faucet

## Model Configurations

**27 C 4 2 2 2 -LS**

Cartridge	Variation	Outlet	Handle	Options
<b>C</b> - CER-TECK® <b>T</b> - TUF-TECK®	<b>2</b> - 8.0" (203 mm) Tubular spout <b>3</b> - 6.0" (152 mm) Tubular spout <b>8</b> - 4.5" (114 mm) Gooseneck spout <b>9</b> - 6.0" (152 mm) Gooseneck spout	<b>2</b> - Vandal resistant laminar outlet 1.5 gpm (5.7 L/min) <b>3</b> - Vandal resistant aerator 1.5 gpm (5.7 L/min) <b>4</b> - Standard aerator outlet 1.5 gpm (5.7 L/min) <b>5</b> - Vandal resistant spray outlet 0.5 gpm (1.9 L/min) <b>6</b> - Smooth end laminar 1.5 gpm (5.7 L/min) <b>7</b> - Smooth end laminar 1.0 gpm (3.8 L/min)	<b>2</b> - Hooded blade 4" (102 mm) <b>3</b> - Hooded lever 3" (76 mm) <b>4</b> - Blade with sanitary hood 4" (102 mm) <b>5</b> - Wrist with sanitary hood 6" (152 mm)	<b>LS</b> - 120° Limited swing gooseneck <b>TI</b> - Handle temperature indicators "H" (red), "C" (blue) <b>R#</b> - Optional gooseneck: (spout dimensions) <b>R5</b> - 6.0" (152 mm) long, 13.25" (337 mm) high <b>R6</b> - 6.0" (152 mm) long, 14.875" (378 mm) high <b>R7</b> - 9.0" (229 mm) long, 13.875" (352 mm) high <b>S#</b> - Optional swing spout dimensions: (spout dimensions) <b>S7</b> - 11.0" (279 mm) Tubular <b>S8</b> - 14.0" (356 mm) Tubular

**NOTICE** Configurations vary, see table on next page for availability.

## Specification

- **HEAVY DUTY CAST BRASS** sink faucet
- 4.0" (102 mm) center two handle
- Polished chrome-plated finish with polished underspout
- **BRASS** swing spout or 3/8" IPS **BRASS PIPE** Rigid/Swivel Gooseneck Spout
- Metal hold-down package
- Designed for routine 180°F (82°C) disinfection cycles up to 30 mins
- Color indexed metal handles with vandal resistant screws
- **Cartridges**
  - CER-TECK® - 1/4 turn ceramic structures or
  - TUF-TECK® - Compression structures

## Optional Features

- "TI" signifies handle temperature indicators "H" (red), "C" (blue). Available on selected models.
- "LS" signifies 120° Limited Swing. Available on selected models.

## NOTICE

- **Optional Rigid/Swivel & Limited Swing Spouts** - see DSP-R/S for detailed specification.
- **For Optional Swing Spouts** - see DSP-S/S for detailed specification.



**27C4222**  
**27T4222**

**27C4322**  
**27T4322**



**27C4822**  
**27T4822**



**27C4922**  
**27T4922**

Masco Canada Limited reserves the right (1) to make changes in specifications and materials, and (2) to change or discontinue models, both without notice or obligation. See current full-line price book or [www.deltafaucet.ca](http://www.deltafaucet.ca) for finish options and product availability.

WaterSense® is a registered trademark of the U.S. Environmental Protection Agency.



© 2025 Masco Canada Limited  
350 South Edgeware Road  
St. Thomas, ON N5P 4L1 Canada  
1-800-387-8277

Dimensions are for reference only, measurements may vary ± 0.25" (6 mm).  
Maximum flow rates - 60 psi (414 kPa)

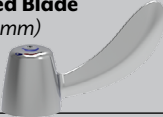
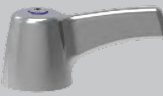
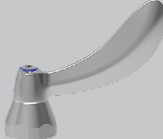
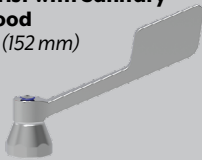
**Two-Handle 4.0" (102 mm) Deck-Mount Faucet**

Available Models	Variations						
	2 Tubular Spout (S5) 8.0" (203 mm)	3 Tubular Spout (S3) 8.0" (203 mm)	8 Gooseneck Spout (R2) 4.5" (114 mm) long, 11.75" (298 mm) high		9 Gooseneck Spout (R4) 6.0" (152 mm) long, 11.625" (295 mm) high		
<b>2</b> Hooded Blade 4" (102 mm) 	27C4222 27C4232 27C4242 27C4242-S7	27C4332 27C4342	27C4822 27C4832 27C4842	27C4842-TI 27C4852 27C4852-TI 27C4872	27C4922 27C4922-LS-TI 27C4922-R7 27C4932 27C4932-R7	27C4942 27C4942-LS 27C4942-R6 27C4952 27C4952-LS	27C4962 27C4962 27C4972
<b>3</b> Hooded Lever 3" (76 mm) 	27C4223 27C4233 27C4243 27C4243-S8 27C4253	27C4323 27T4333 27C4333 27C4343 27C4353	27C4823 27C4833 27C4833-TI 27C4843 27C4843-TI 27C4853 27C4873	27T4833 27T4843	27C4923 27C4933 27C4933-LS 27C4933-R7	27C4943 27C4943-R7 27C4953 27C4973-TI	27T4933
<b>4</b> Blade with Sanitary Hood 4" (102 mm) 	27C4224 27C4234 27C4244 27C4254	27C4324 27C4344	27C4824 27C4834 27C4834-TI 27C4844 27C4844-TI 27C4854 27C4864 27C4864-R7 27C4874 27C4874-TI	27T4824 27T4834 27T4844 27T4864 27T4874	27C4924 27C4924-LS 27C4924-R5 27C4924-R7 27C4924-TI 27C4934 27C4934-LS 27C4934-LS-TI 27C4934-R7 27C4934-TI	27C4944 27C4944-LS 27C4944-LS-TI 27C4944-R5 27C4944-R7 27C4944-TI 27C4954 27C4954-LS-TI 27C4954-R7 27C4964	27C4964-R7 27C4974 27C4974-LS-TI 27C4974-R7 27C4974-TI
<b>5</b> Wrist with Sanitary Hood 6" (152 mm) 	27C4235		27C4835 27C4845		27C4925 27C4925-R7 27C4955 27C4975	27T4975	

**Complies With**

- ASME A112.18.1/CSA B125.1
-  Indicates compliance to ICC / ANSI A117.1
-  Outlet options 2, 3, 4, 6 and 7 are EPA WaterSense® listed
-  Verified compliant with 0.25% weighted average Pb content regulations
- Certified to NSF/ANSI 372 - Drinking Water System Components - Lead Content
- Models are found to have a Q Value of ≤ 1 of NSF/ANSI/CAN 61 Drinking Water System Components - Health Effects

(Contact Delta Representative for State and/or Local Approvals.)

Masco Canada Limited reserves the right (1) to make changes in specifications and materials, and (2) to change or discontinue models, both without notice or obligation. See current full-line price book or [www.deltafaucet.ca](http://www.deltafaucet.ca) for finish options and product availability.

WaterSense® is a registered trademark of the U.S. Environmental Protection Agency.

Dimensions are for reference only, measurements may vary ± 0.25" (6 mm).  
Maximum flow rates - 60 psi (414 kPa)

Engineer/Architect Approval	
Model Specified:	
Approval:	Date:

# Two-Handle 4.0" (102 mm) Deck-Mount Faucet

## Front View

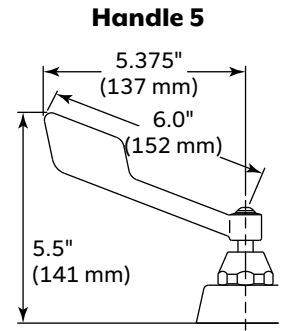
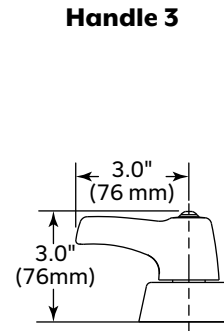
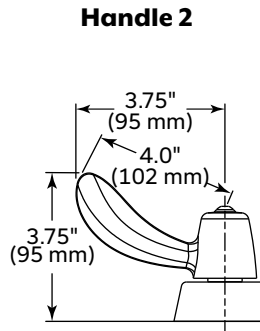
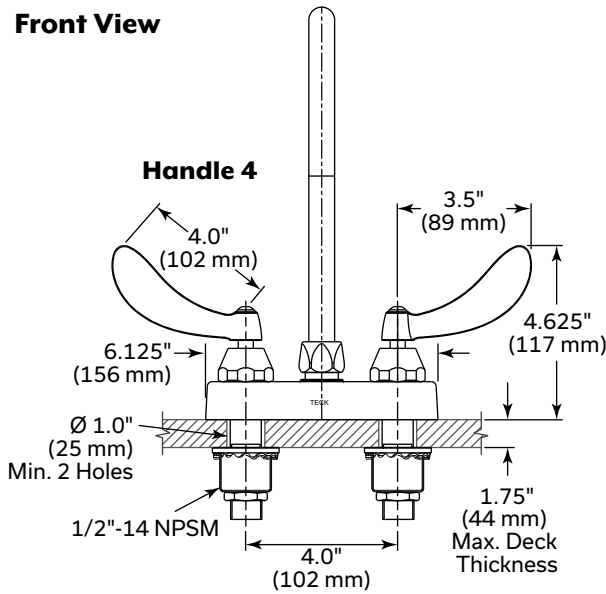

Inlet for 3/8" or 1/2" flexible riser or 1/2"-14 NPSM coupling nut. (Not Supplied)

## Swing Spouts

### Outlets #2, 3, 4 & 5

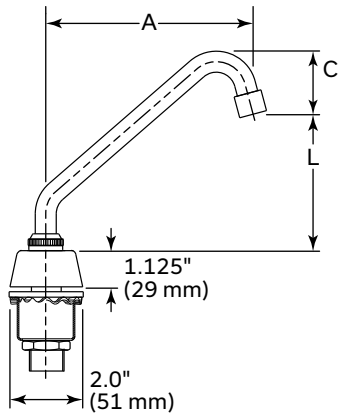

## Gooseneck Spouts

### Outlets #2, 3, 4 & 5

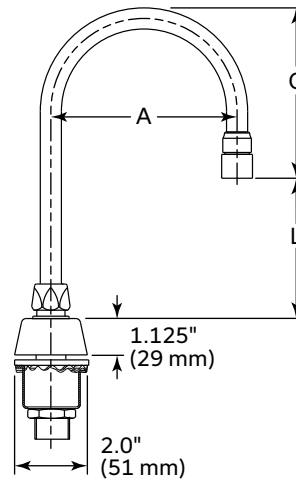

### Outlet #6 & 7

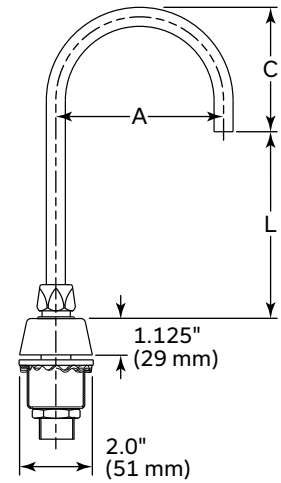

## Spout Assemblies

Variation	Spout Type/Outlet	"A"		"C"		"L"	
		in.	mm	in.	mm	in.	mm
2	8.0" (203 mm) Tubular Spout (S5)/Outlets #2, 3, 4 & 5	8.25	210	2.625	67	5.25	133
3	6.0" (152 mm) Tubular Spout (S3)/Outlets #2, 3, 4 & 5	6.5	165	2.375	60	3.625	92
8	Gooseneck Spout (R2)/Outlets #2, 3, 4 & 5	4.5	114	4.625	117	6.0	152
	Gooseneck Spout (R2)/Outlet #6 & 7			3.875	98	7.0	178
9	Gooseneck Spout (R4)/Outlets #2, 3, 4 & 5	6.0	152	5.5	140	5.25	133
	Gooseneck Spout (R4)/Outlet #6 & 7			5.25	133	5.375	137

Masco Canada Limited reserves the right (1) to make changes in specifications and materials, and (2) to change or discontinue models, both without notice or obligation. See current full-line price book or [www.deltafaucet.ca](http://www.deltafaucet.ca) for finish options and product availability.

WaterSense® is a registered trademark of the U.S. Environmental Protection Agency.

© 2025 Masco Canada Limited  
350 South Edgeware Road  
St. Thomas, ON N5P 4L1 Canada  
1-800-387-8277

Dimensions are for reference only, measurements may vary ± 0.25" (6 mm).  
Maximum flow rates - 60 psi (414 kPa)

# Robinet à deux poignées de 4,0 po (102 mm), installation sur le comptoir

Configuration des modèles

## 27C4222-LS

Cartouche	Variation	Sortie	Poignées	Options
<b>C</b> - CER-TECK <sup>MD</sup>	<b>2</b> - 8.0 po (203 mm) Bec tubulaire	<b>2</b> - Sortie laminaire à l'épreuve du vandalisme 1,5 gpm (5,7 L/min)	<b>2</b> - Lame à capuchon 4 po (102 mm)	<b>LS</b> - Bec col de cygne à pivotement limité de 120°
<b>T</b> - TUF-TECK <sup>MD</sup>	<b>3</b> - 6.0 po (152 mm) Bec tubulaire	<b>3</b> - Aérateur à l'épreuve du vandalisme 1,5 gpm (5,7 L/min)	<b>3</b> - Levier à capuchon 3 po (76 mm)	<b>TI</b> - Indicateur de température sur la poignée (rouge=chaud, bleu = froid)
	<b>8</b> - 4.5 po (114 mm) Bec col de cygne	<b>4</b> - Aérateur standard 1,5 gpm (5,7 L/min)	<b>4</b> - Lame avec capuchon sanitaire 4 po (102 mm)	<b>R#</b> - Col de cygne en option : (dimensions du bec)
	<b>9</b> - 6.0 po (152 mm) Bec col de cygne	<b>5</b> - Sortie de jet à l'épreuve du vandalisme 0,5 gpm (1,9 L/min)	<b>5</b> - Coudée avec capuchon sanitaire 6 po (152 mm)	<b>R5</b> - longueur : 6 po (152 mm), hauteur : 13,25 po (337 mm)
		<b>6</b> - Bout lisse, sortie laminaire 1,5 gpm (5,7 L/min)		<b>R6</b> - longueur : 6 po (152 mm), hauteur : 14,875 po (378 mm)
		<b>7</b> - Bout lisse, sortie laminaire 1,0 gpm (3,8 L/min)		<b>R7</b> - longueur : 9 po (229 mm), hauteur : 13,875 po (352 mm)
				<b>S#</b> - Col de cygne en option : (dimensions du bec)
				<b>S7</b> - Bec tubulaire 11 po (279 mm)
				<b>S8</b> - Bec tubulaire 14 po (356 mm)

**AVIS** Les configurations varient, voir le tableau à la page suivante pour la disponibilité.

### Spécification

- Robinet de cuisine **EN LAITON FONDU ULTRARÉSISTANT**
- 4,0 po (102 mm) centre à centre, deux poignées
- Fini chromé poli avec sous-bec poli
- Bec pivotant en **LAITON** ou bec col de cygne fixe ou pivotant avec **TUYAU EN LAITON** de 3/8 po IPS
- Ensemble de retenue métallique
- Conçu pour des cycles de désinfection de routine à 180 °F (82 °C) jusqu'à 30 minutes
- **Cartouches**
  - CER-TECK<sup>MD</sup> - Structure de céramique 1/4 de tour ou
  - TUF-TECK<sup>MD</sup> - Cartouche à compression

### Caractéristiques en option

- « **TI** » signifie les indicateurs de température sur la poignée (rouge = chaud, bleu = froid). Offert sur certains modèles.
- « **LS** » signifie le bec col de cygne à pivotement limité à 120°. Offert sur certains modèles.

**AVIS**

- **Becs pivotants offerts en option** - pour des spécifications détaillées, se reporter au DSP-R/SF.
- **Becs pivotants offerts en option** - pour des spécifications détaillées, se reporter au DSP-S/SF.



**27C4222**  
**27T4222**



**27C4322**  
**27T4322**



**27C4822**  
**27T4822**



**27C4922**  
**27T4922**



Delta Faucet Company se réserve le droit (1) d'effectuer des changements dans les spécifications et les matériaux, et (2) de modifier ou d'abandonner certains modèles, dans les deux cas sans préavis ni obligation. Consultez le livre des prix courants de la gamme complète ou [www.deltafaucet.ca](http://www.deltafaucet.ca) pour la disponibilité des produits et des options.

WaterSense<sup>MC</sup> est une marque déposée de l'Agence de protection de l'environnement des États-Unis.

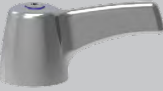

© 2025 Masco Canada Limited  
350 South Edgeware Road  
St. Thomas, ON N5P 4L1 Canada  
1-800-387-8277

Les dimensions ne sont fournies qu'à titre de référence seulement, les mesures peuvent varier de ± 0,25 po (6 mm).  
Volumes des chasses d'eau - 60 psi (414 kPa).

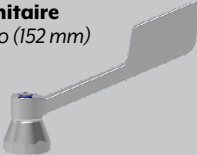
**Robinet à deux poignées de 4,0 po (102 mm),  
installation sur le comptoir**

Modèles offerts	Variations						
	2 Bec tubulaire (S5) 8 po (203 mm)	3 Bec tubulaire (S3) 8 po (203 mm)	8 Bec col de cygne(R2) longueur - 4,5 po (114 mm), hauteur - 1 1,75 po (298 mm)	9 Bec col de cygne(R4) longueur - 6 po (152 mm), hauteur - 11,625 po (295 mm)			
<b>2</b> Lame à capuchon 4 po (102 mm) 	27C4222 27C4232 27C4242 27C4242-S7	27C4332 27C4342	27C4822 27C4832 27C4842	27C4842-TI 27C4852 27C4852-TI 27C4872	27C4922 27C4922-LS-TI 27C4922-R7 27C4932 27C4932-R7	27C4942 27C4942-LS 27C4942-R6 27C4952 27C4952-LS	27C4962 27C4962 27C4972
<b>3</b> Levier à capuchon 3 po (76 mm) 	27C4223 27C4233 27C4243 27C4243-S8 27C4253	27C4323 27C4333 27C4343 27C4353	27C4823 27C4833 27C4833-TI 27C4843 27C4843-TI 27C4853 27C4873	27T4833 27T4843	27C4923 27C4933 27C4933-LS 27C4933-R7	27C4943 27C4943-R7 27C4953 27C4973-TI	27T4933
<b>4</b> Lame avec capuchon sanitaire 4 po (102 mm) 	27C4224 27C4234 27C4244 27C4254	27C4324 27C4344	27C4824 27C4834 27C4834-TI 27C4844 27C4844-TI 27C4854 27C4864 27C4864-R7 27C4874 27C4874-TI	27T4824 27T4834 27T4844 27T4864 27T4874	27C4924 27C4924-LS 27C4924-R5 27C4924-R7 27C4924-TI 27C4934 27C4934-LS 27C4934-LS-TI 27C4934-R7 27C4934-TI	27C4944 27C4944-LS 27C4944-LS-TI 27C4944-R5 27C4944-R7 27C4944-TI 27C4954 27C4954-LS-TI 27C4954-R7 27C4964	27C4964-R7 27C4974 27C4974-LS-TI 27C4974-R7 27C4974-TI 27T4934 27T4944 27T4964 27T4974
<b>5</b> Coudée avec capuchon sanitaire 6 po (152 mm) 	27C4235		27C4835 27C4845		27C4925 27C4925-R7 27C4955 27C4975	27T4975	

**Conforme à**

- ASME A112.18.1/CSA B125.1
-  Indique la conformité à la norme ICC / ANSI A117.1
-  Options de sortie 2, 3, 4, 6 et 7 homologuées WaterSense<sup>MP</sup> de l'EPA
-  Conformité vérifiée avec les règlements concernant le poids moyen de 0,25 % du contenu en Pb
- Certifié NSF/ANSI 372 - Composants des systèmes d'eau potable - Teneur en plomb
- Les modèles ont une valeur Q ≤ 1 selon la norme NSF/ANSI/CAN 61 Composants des systèmes d'eau potable - Effets sur la santé

(Communiquez avec un représentant Delta pour connaître les approbations d'État et/ou locales.)

Delta Faucet Company se réserve le droit (1) d'effectuer des changements dans les spécifications et les matériaux, et (2) de modifier ou d'abandonner certains modèles, dans les deux cas sans préavis ni obligation. Consultez le livre des prix courants de la gamme complète ou [www.deltafaucet.ca](http://www.deltafaucet.ca) pour la disponibilité des produits et des options.

WaterSense<sup>MP</sup> est une marque déposée de l'Agence de protection de l'environnement des États-Unis.

Les dimensions ne sont fournies qu'à titre de référence seulement, les mesures peuvent varier de ± 0,25 po (6 mm).  
Volumés des chasses d'eau - 60 psi (414 kPa).

Approbation de l'ingénieur / de l'architecte	
Modèle spécifié :	
Approbation :	Date:

© 2025 Masco Canada Limited  
350 South Edgeware Road  
St. Thomas, ON N5P 4L1 Canada  
1-800-387-8277

# Robinet à deux poignées de 4,0 po (102 mm), installation sur le comptoir

## Vue de face

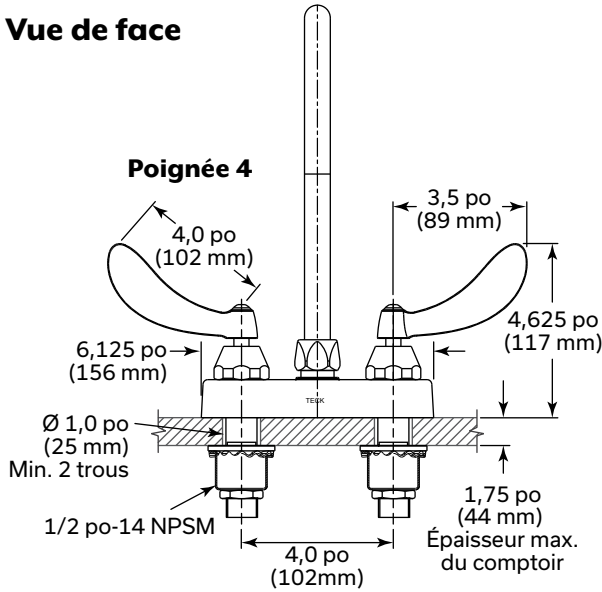

### Poignée 2

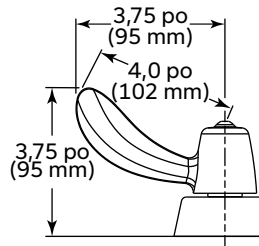

### Poignée 3

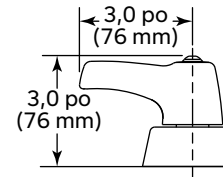

### Poignée 5

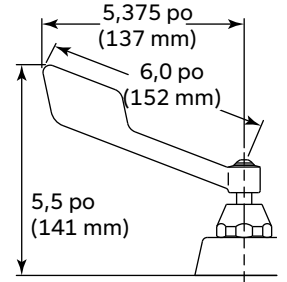

Entrée pour colonne flexible de 0,375 po ou 0,5 po ou écrou-raccord de 1/2 po-14 NPSM. (Non Compris)

## Becs pivotants

### Sortie n° 2, 3, 4 et 5

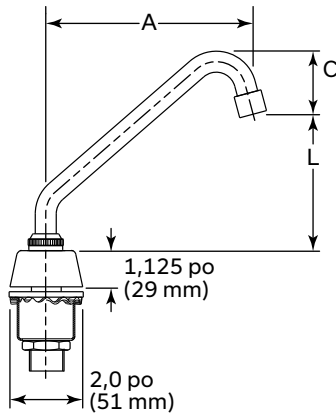

## Becs col de cygne

### Sortie n° 2, 3, 4 et 5

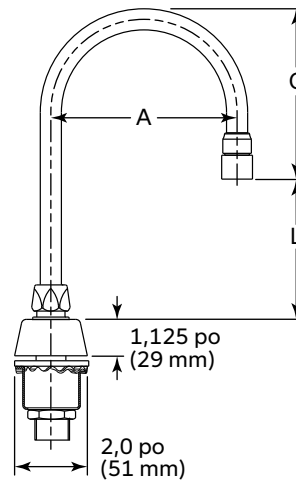

### Sortie n° 6 et 7

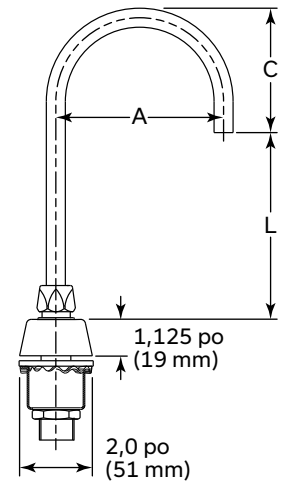

## Ensembles de bec

Variation	Bec/Sortie	"A"		"C"		"L"	
		po	mm	po	mm	po	mm
2	Bec tubulaire de 8,0 po (S5)/Sorties no 2, 3, 4 et 5	8.25	210	2.625	67	5.25	133
3	Bec tubulaire de 6,0 po (152 mm) (S3)/Sorties no 2, 3, 4 et 5	6.5	165	2.375	60	3.625	92
8	Col de cygne-standard (R2)/Sorties no 2, 3, 4 et 5	4.5	114	4.625	117	6.0	152
	Col de cygne-standard (R2)/Sorties no 6 et 7			3.875	98	7.0	178
9	Col de cygne-standard (R4)/Sorties no 2, 3, 4 et 5	6.0	152	5.5	140	5.25	133
	Col de cygne-standard (R4)/Sorties no 6 et 7			5.25	133	5.375	137

Delta Faucet Company se réserve le droit (1) d'effectuer des changements dans les spécifications et les matériaux, et (2) de modifier ou d'abandonner certains modèles, dans les deux cas sans préavis ni obligation. Consultez le livre des prix courants de la gamme complète ou [www.deltafaucet.ca](http://www.deltafaucet.ca) pour la disponibilité des produits et des options.

WaterSense<sup>™</sup> est une marque déposée de l'Agence de protection de l'environnement des États-Unis.

© 2025 Masco Canada Limited  
350 South Edgeware Road  
St. Thomas, ON N5P 4L1 Canada  
1-800-387-8277

Les dimensions ne sont fournies qu'à titre de référence seulement, les mesures peuvent varier de ± 0,25 po (6 mm).  
Volumes des chasses d'eau - 60 psi (414 kPa).