

Submitted Model No.: _____

Specific Features: _____

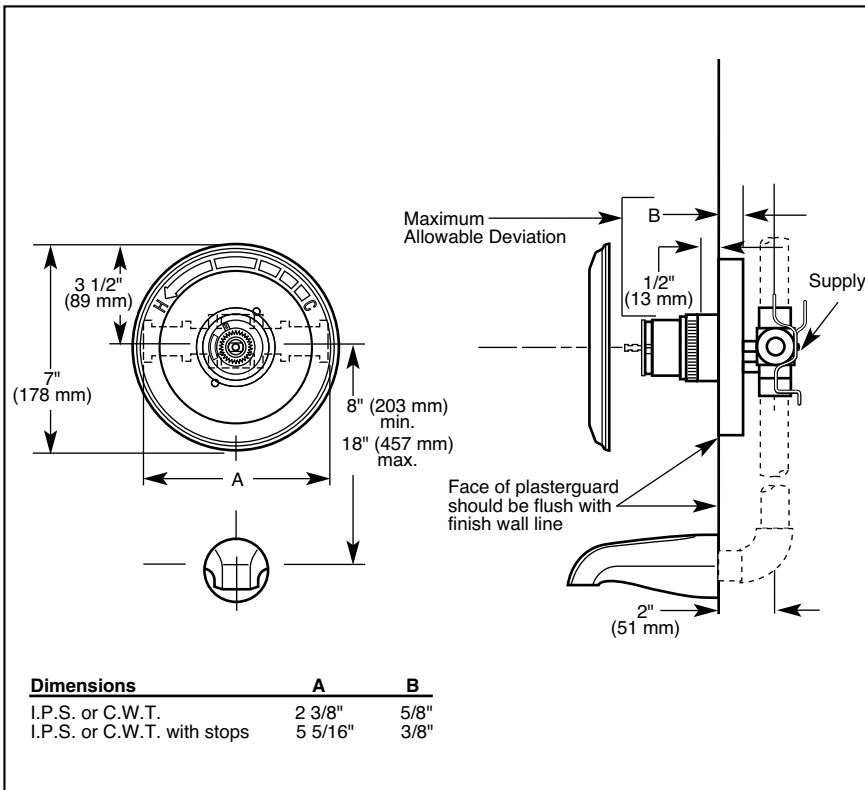

DELTA

BATH MIXING VALVES

- Valve Only (1404 Series)
- Tub Only (1412 Series)
- Single Handle
- LHP-Less Handle Program
- Monitor® with Scald-Guard® Valve
- Pressure Balance
- Temperature Only Controlled with Handle



UL Listed to US and Canadian Safety Standards 21PL

COMPLIES WITH:

- ASME A112.18.1M-1996
- ASSE 1016-1996
- CSA B125-93
- Indicates ADA compliance to CABO/ANSI A117.1-1992
- ASSE Seal Authorized
- City of L.A. approved
- CSA Certified
- IAPMO Listed

STANDARD SPECIFICATIONS:

- Pressure balanced single handle bath mixing valve.
- Requires 1 1/2" (38 mm) wall cavity.
- Back-to-back installation capability.
- Solid brass fabricated body.
- LHP-Less Handle Program. See available handle options on back.
- Monitor® with Scald-Guard® valve. Maintains a balanced pressure of hot and cold water even when a valve is turned on or off elsewhere in the system.
- Temperature only controlled with handle.
- Field adjustable to limit handle rotation into hot water zone.
- 120° maximum handle rotation.
- All parts shall be replaceable from the front of the valve.

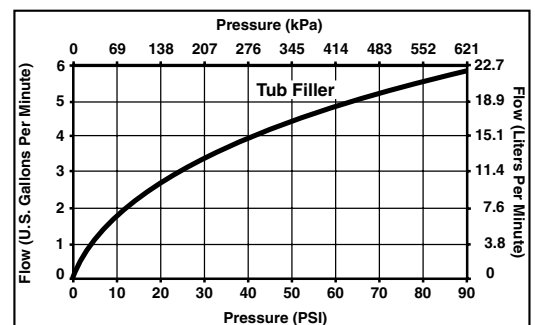





Standard Features	1404-CLHP	1404-CPBLHP	1404-CWHLHP	1404-CWSLHP	1404-LHP	1404-PBLHP	1404-WHLHP	1412-CLHP	1412-LHP	1412-PBLHP
Washerless	◆	◆	◆	◆	◆	◆	◆	◆	◆	◆
Scald-Guard® Valve	◆	◆	◆	◆	◆	◆	◆	◆	◆	◆
Back-to-Back Installation	◆	◆	◆	◆	◆	◆	◆	◆	◆	◆
1/2" I.P.S. Inlets and Outlets					◆	◆	◆		◆	◆
1/2" C.W.T. Sweat Inlets and Outlets	◆	◆	◆	◆				◆		
Less Handle Program-See Handle Kit Options*	◆	◆	◆	◆	◆	◆	◆	◆	◆	◆
Metal Over-the-Rim Tub Filler								◆	◆	◆
Screwdriver Stops				◆						
Chrome Finish	◆			◆	◆			◆	◆	
Brilliance™ Polished Brass Finish		◆				◆				◆
White Finish			◆				◆			

Available Options for Field Conversion:



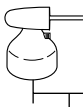

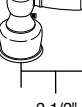

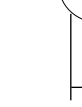
- Screwdriver Stops. Order two RP5876s for I.P.S. or two RP6005s for C.W.T.
- Metallic tub filler with pull-down diverter for 1/2" C.W.T. or 1/2" I.P.S. Order RP17454▲.
- Non-metallic tub filler with pull-down diverter for 1/2" C.W.T. or 1/2" I.P.S. Order RP17453 (chrome only).
- Non-metallic slip-on tub filler with pull-down diverter for 1/2" C.W.T. Order RP5836 (chrome only).
- Metallic slip-on tub filler with pull-down diverter for 1/2" C.W.T. Order RP19581PB (*Brilliance*™ polished brass only).
- Metallic tub filler with pull-up diverter for 1/2" C.W.T. or 1/2" I.P.S. Order RP7533▲.
- Non-metallic tub filler with pull-up diverter for 1/2" C.W.T. or 1/2" I.P.S. Order RP5834 (chrome only).
- Non-metallic slip-on tub filler with pull-up diverter for 1/2" C.W.T. Order RP19820 (chrome only).
- Metallic over-the-rim tub filler for 1/2" I.P.S. Order RP5833▲.
- Metallic over-the-rim slip-on tub filler for 1/2" C.W.T. Order RP5835 (chrome only).
- Bath waste assemblies and bath accessories also available separately.



▲=Specify Finish

***Available LHP Handle Options**

H71▲  1 1/2" (38 mm)	H72▲ A72  2 3/8" (60 mm)	H73▲ A73  1 1/8" (29 mm)	H74▲ A74  3 1/4" (83 mm)
H75▲  2 1/2" (64 mm)	H77▲  1 5/8" (41 mm)	H78  2 1/4" (57 mm)	H79▲  3 3/8" (86 mm)

***Available LHP Handle Accent Options**

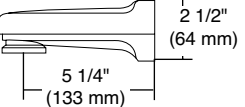
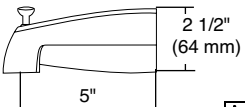
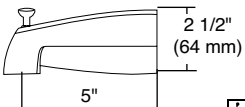
 A72CL	 A74, A74AL, A74PB, A74WH
 A72, A72AL, A72PB, A72PR, A72WH	 A73, A73PB, A73WH
 A72OK	 A73ST
 A74CL	

RP5836 RP17453 RP17454▲ RP19581PB	 2 1/2" (64 mm) 5 1/4" (133 mm)
RP5834 RP7533▲	 2 1/2" (64 mm) 5" (127 mm)
RP19820	 2 1/2" (64 mm) 5" (127 mm)
RP5833▲ RP5835	 2 1/2" (64 mm) 4 3/4" (121 mm)



Indianapolis, Indiana 46280
A Division of Masco Corporation of Indiana
© 2001 Masco Corporation of Indiana