

DELTA

BATH MIXING VALVES

- Shower Only (1430)
- Tub/Shower (1460 & 1480)
- Single Handle
- LHP-Less Handle Program
- Monitor® with Scald-Guard® Valve
- Pressure Balance
- Temperature Only Controlled with Handle
- Universal Fittings

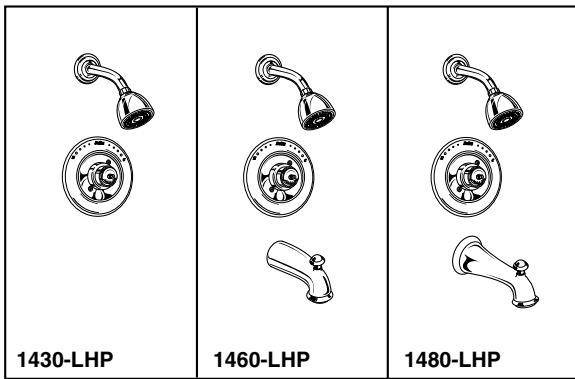

Submitted Model No.: _____

Specific Features: _____

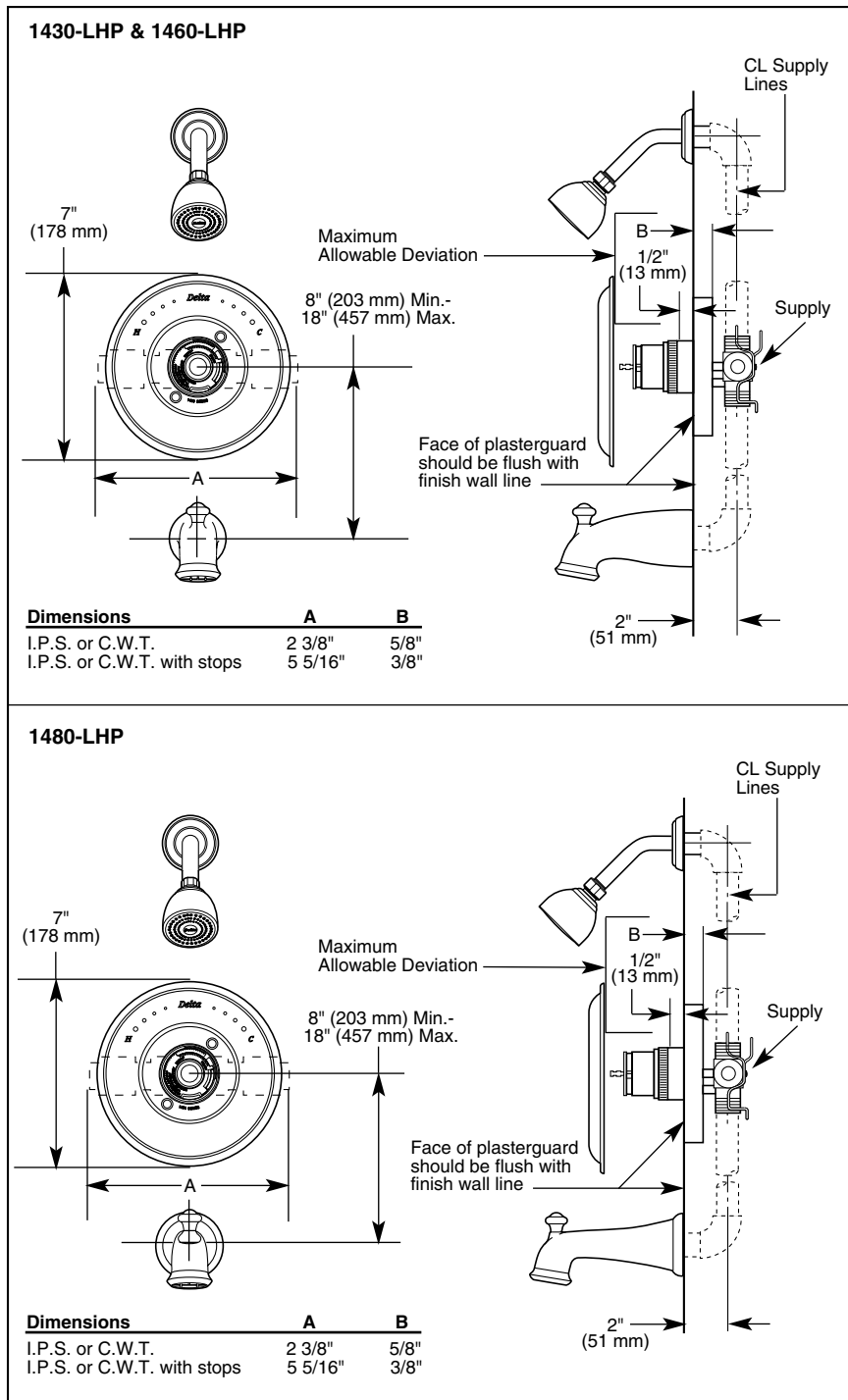

COMPLIES WITH:

- ASME A112.18.1
- ASSE 1016
- CSA B125
- Indicates ADA compliance to ICC/ANSI A117.1
- ASSE Seal Authorized
- CSA Certified
- IAPMO Listed

STANDARD SPECIFICATIONS:

- Pressure balanced single handle bath mixing valve.
- Requires 1 1/2" (38 mm) wall cavity.
- Back-to-back installation capability.
- Solid brass fabricated body.
- LHP-Less Handle Program. See available handle options on back.
- Monitor® with Scald-Guard® valve. Maintains a balanced pressure of hot and cold water even when a valve is turned on or off elsewhere in the system.
- Temperature only controlled with handle.
- Field adjustable to limit handle rotation into hot water zone.
- 120° maximum handle rotation.
- All parts shall be replaceable from the front of the valve.

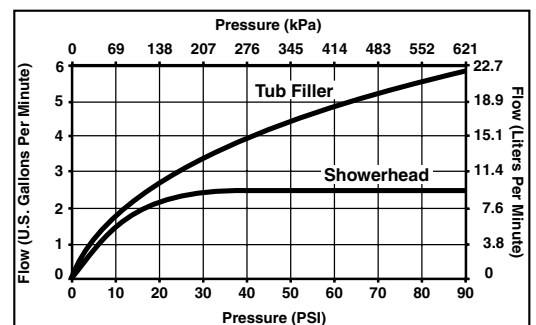

Delta reserves the right (1) to make changes in specifications and materials, and (2) to change or discontinue models, both without notice or obligation. Dimensions are for reference only.

Standard Features	1430-LHP	1430-CBLHP	1460-LHP	1460-CBLHP	1480-LHP	1480-CBLHP
Washerless	◆	◆	◆	◆	◆	◆
1/2" I.P.S. Inlets and Outlets	◆	◆	◆	◆	◆	◆
1/2" C.W.T. Sweat Inlets and Outlets	◆	◆	◆	◆	◆	◆
Less Handle Program- See Handle Kit Options*	◆	◆	◆	◆	◆	◆
Metal Shower Arm and Flange	◆	◆	◆	◆	◆	◆
Single Spray Touch-Clean® Showerhead	◆		◆		◆	
Non-Metallic Dual Spray Touch-Clean® Showerhead/2 Spray Pattern		◆		◆		◆
Tub Filler w/Pull-Up Diverter			◆	◆	◆	◆
Chrome Finish	◆		◆		◆	
Chrome and <i>Brilliance</i> ® Polished Brass Finish		◆		◆		◆

- Available Options for Field Conversion:**
- Screwdriver Stops. Order two RP5876s for I.P.S. or two RP6005s for C.W.T.
 - Shower Arm. Order RP6023▲.
 - Shower Flange.
 - Non-Metallic Push Clean™ showerhead/1 spray pattern. Order RP28599▲.
 - Non-Metallic Dual Spray Touch-Clean® showerhead/2 spray patterns. Order RP28601▲.
 - Non-Metallic Ultimate Touch-Clean® showerhead/3 spray patterns. Order RP28602▲.
 - Brass shower arm diverter for hand shower. Order RP4239 (chrome only).
 - Personal hand shower with 24" vertical bar, 60" hose. Order RP7245 (chrome only).
 - Personal hand shower with 24" vertical bar, 60" hose, vacuum breaker and wall supply elbow. Order RPW1111HDF (chrome only).
 - Personal hand shower with 60" hose, vacuum breaker and wall supply elbow. Order RPW2222HDF (chrome only).
 - Metallic tub filler with pull-down diverter for 1/2" C.W.T. or 1/2" I.P.S. Order RP17454▲.
 - Non-metallic tub filler with pull-down diverter for 1/2" C.W.T. or 1/2" I.P.S. Order RP17453 (chrome only).
 - Non-metallic slip-on tub filler with pull-down diverter for 1/2" C.W.T. Order RP5836 (chrome only).
 - Metallic tub filler with pull-up diverter for 1/2" C.W.T. or 1/2" I.P.S. Order RP7533▲.
 - Non-metallic tub filler with pull-up diverter for 1/2" C.W.T. or 1/2" I.P.S. Order RP5834 (chrome only).
 - Non-metallic slip-on tub filler with pull-up diverter for 1/2" C.W.T. Order RP19820 (chrome only).
 - Metallic over-the-rim tub filler for 1/2" I.P.S. Order RP5833▲.
 - Metallic over-the-rim slip-on tub filler for 1/2" C.W.T. Order RP5835 (chrome only).
 - Bath waste assemblies and bath accessories also available separately.

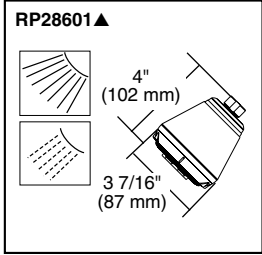
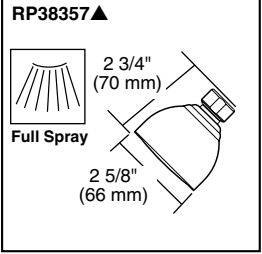
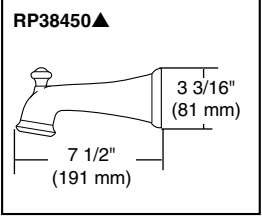
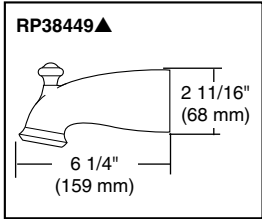

***Available LHP Handle Options**

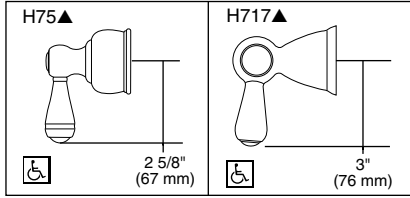

▲ = Specify Finish
† Designates the accent color on split finish models.



Indianapolis, Indiana 46280
A Division of Masco Corporation of Indiana
© 2002 Masco Corporation of Indiana