

Submitted Model No.: \_\_\_\_\_  
 Specific Features: \_\_\_\_\_

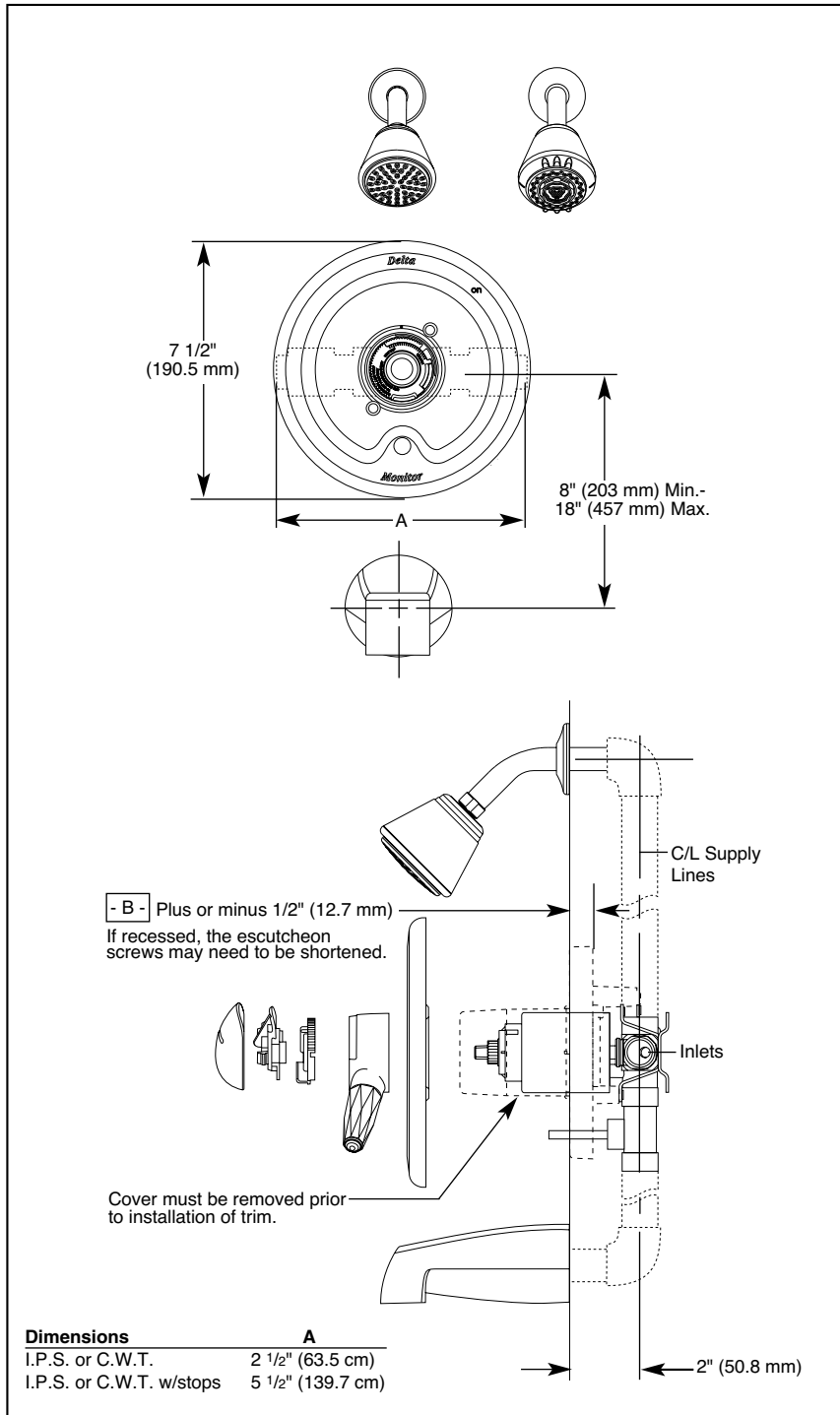

Dimensions	A
I.P.S. or C.W.T.	2 1/2" (63.5 cm)
I.P.S. or C.W.T. w/stops	5 1/2" (139.7 cm)



# BATH MIXING VALVES

- Valve Only (1708 Series)
- Tub/Shower (1738 Series)
- Single Handle
- Push Button Diverter
- Monitor® with Scald-Guard® Valve
- Pressure Balance
- Volume Controlled with Lever Handle
- Temperature Controlled with Dial



UL Listed to US and Canadian Safety Standards 21PL

### COMPLIES WITH:

- ASME A112.18.1M-1996
- ASSE 1016-1996
- CSA B125-93
- Showerhead GSA A-A-240
- Indicates ADA compliance to CABO/ANSI A117.1-1992
- ASSE Seal Authorized
- City of L.A. approved
- CSA Certified
- IAPMO Listed

### STANDARD SPECIFICATIONS:

- Requires 1 1/2" (38 mm) wall cavity.
- Back-to-back installation capability.
- Solid brass fabricated body.
- Push button diverter.
- Monitor® with Scald-Guard® valve. Maintains a balanced pressure of hot and cold water even when a valve is turned on or off elsewhere in the system.
- Lever Volume control handle; temperature adjustment dial.
- Field adjustable to limit dial rotation into hot water zone.
- Maximum dial rotation adjustable between 90° and 180°.
- Red and Blue graphics indicate hot/cold temperature adjustment.

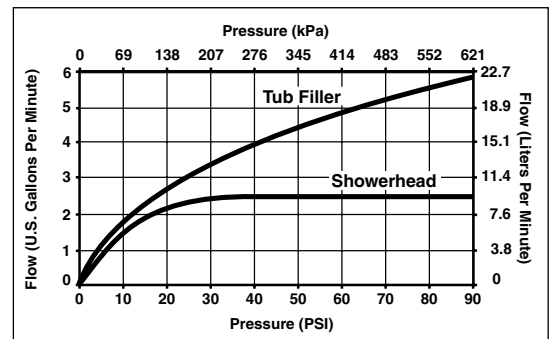





Standard Features	1708	1738	1738-C	1738-CWS	1738-PB	1738-WHBR
Washerless	◆	◆	◆	◆	◆	◆
Scald-Guard® Valve	◆	◆	◆	◆	◆	◆
Back-to-Back Installation	◆	◆	◆	◆	◆	◆
½" I.P.S. Inlets and Outlets	◆	◆			◆	◆
½" C.W.T. Sweat Inlets and Outlets			◆	◆		
Replaceable Cartridge	◆	◆	◆	◆	◆	◆
Adjustable Rotational Limit Stop	◆	◆	◆	◆	◆	◆
Matching Finish Temperature Adjustment Dial	♿	♿	♿	♿	♿	♿
Volume Control Clear Lever Handle*	♿	♿	♿	♿	♿	
White Volume Control Clear Lever Handle*						♿
Push-Button Diverter	◆	◆	◆	◆	◆	◆
Metal Shower Arm and Flange		◆	◆	◆	◆	◆
Non-Metallic Touch-Clean® Showerhead/1 Spray Pattern		◆	◆	◆		
Non-Metallic Dual Spray Touch-Clean® Showerhead/2 Spray Patterns					◆	◆
Screwdriver Stops				◆		
Metal Over-the-Rim Tub Filler		◆	◆	◆	◆	◆
Chrome Finish	◆	◆	◆	◆		
Brilliance™ Polished Brass Finish					◆	
White Finish						◆

**Available Options for Field Conversion:**

- Screwdriver Stops. Order two RP5876s for IPS or two RP6005s for C.W.T.
- Shower Arm. Order RP6023▲.
- Shower Flange. Order RP6025▲.
- Non-metallic Push-Clean™ showerhead/1 spray pattern. Order RP28599▲.
- Non-metallic Touch-Clean® showerhead/1 spray pattern. Order RP28600▲.
- Non-metallic Dual Spray Touch-Clean® showerhead/2 spray patterns. Order RP28601▲.
- Non-metallic Ultimate Touch-Clean® showerhead/3 spray patterns. Order RP28602▲.
- Brass shower arm diverter for hand shower. Order RP4239 (chrome only).
- Personal hand shower with 24" vertical bar, 60" hose. Order RP7245 (chrome only).
- Personal hand shower with 24" vertical bar, 60" hose, vacuum breaker and wall supply elbow. Order RPW1111HDF (chrome only).
- Personal handshower with 60" hose, vacuum breaker and wall supply elbow. Order RPW2222HDF (chrome only).
- Metallic over-the-rim tub filler for 1/2" I.P.S. Order RP5833▲.
- Metallic over-the-rim slip-on tub filler for 1/2" C.W.T. Order RP5835 (chrome only).
- Bath waste assemblies and bath accessories also available separately.

▲=Specify Finish

**\*Handle Accents**

	A72CL
	A72, A72AL, A72PB, A72PR, A72WH
	A72OK
	A74CL
	A74, A74AL, A74PB, A74WH

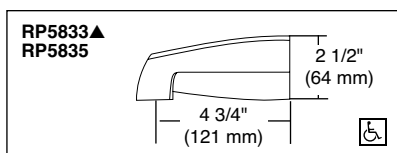

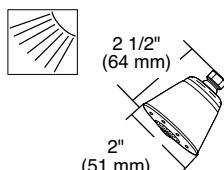
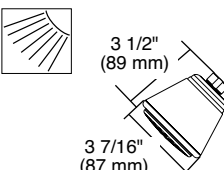
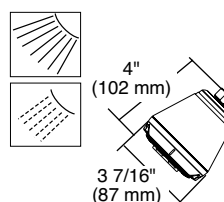
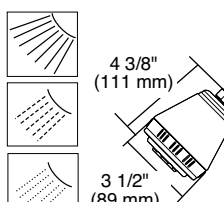
<p><b>RP28599▲</b> Push-Clean™ Showerhead</p>  <p>2 1/2" (64 mm)</p> <p>2" (51 mm)</p>	<p><b>RP28600▲</b> Touch-Clean® Showerhead</p>  <p>3 1/2" (89 mm)</p> <p>3 7/16" (87 mm)</p>
<p><b>RP28601▲</b> Dual Spray Touch-Clean® Showerhead</p>  <p>4" (102 mm)</p> <p>3 7/16" (87 mm)</p>	<p><b>RP28602▲</b> Ultimate Touch-Clean® Showerhead</p>  <p>4 3/8" (111 mm)</p> <p>3 1/2" (89 mm)</p>

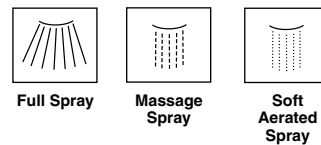

Indianapolis, Indiana 46280  
A Division of Masco Corporation of Indiana  
© 2001 Masco Corporation of Indiana